



EC500-HD

H81



► Features

- Supports DDR3 SODIMM up to 16GB
- 1x 2.5" SATA drive bay
- Compact and cost-effective solution



► Panel

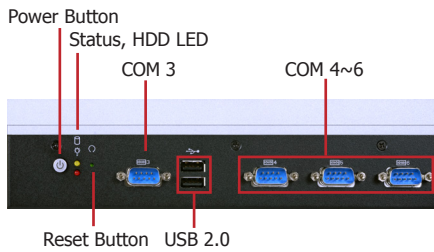

Front View

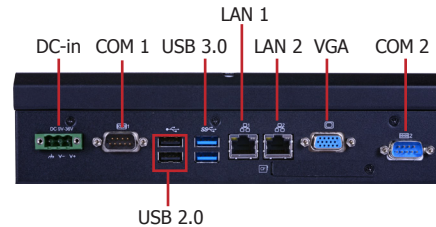

Rear View

► Dimensions

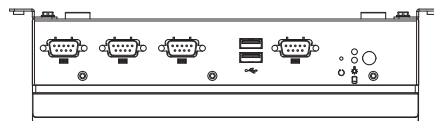

Front View

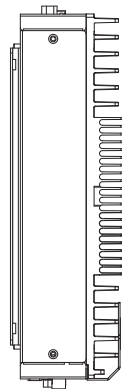

Left View

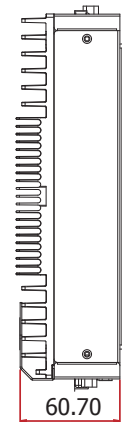
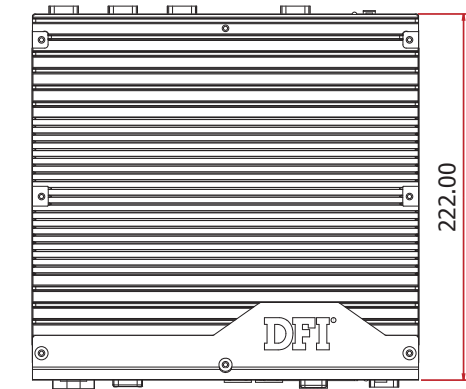

Right View

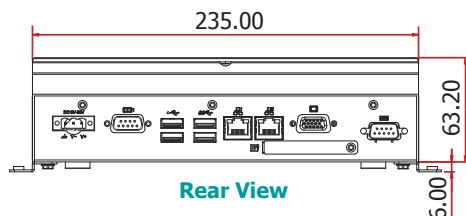

Rear View

6.00

EC500-HD

Specifications * Optional and is not supported in standard model. Please contact your sales representative for more information.

PROCESSOR SYSTEM

- CPU
 - 4th Generation Intel® Core™ processors (22nm process technology)
 - : Intel® Core™ i7-4770TE (8M Cache, up to 3.3 GHz); 45W
 - : Intel® Core™ i5-4590T (6M Cache, up to 3.0 GHz); 35W
 - : Intel® Core™ i5-4570TE (4M Cache, up to 3.3 GHz); 35W
 - : Intel® Core™ i3-4350T (4M Cache, 3.1 GHz); 35W
 - : Intel® Core™ i3-4340TE (4M Cache, 2.6 GHz); 35W
 - : Intel® Core™ i3-4330TE (4M Cache, 2.4 GHz); 35W
 - : Intel® Pentium® G3320TE (3M Cache, 2.3 GHz); 35W
 - : Intel® Celeron® G1820TE (2M Cache, 2.2 GHz); 35W
- Chipset: Intel® H81 Express Chipset

MEMORY

- Two 204-pin DDR3 SODIMM sockets
- Supports DDR3 1333/1600MHz
- Supports up to 16GB system memory
- Supports dual channel memory interface

GRAPHICS

- Intel® HD Graphics
- Display port: 1 VGA
- VGA: 24-bit, resolution up to 1920x1200 @ 60Hz

STORAGE

- 1 2.5" SATA drive bay
 - SATA 3.0 port with data transfer rate up to 6Gb/s
- Supports 1 mSATA module via the mini PCIe socket

ETHERNET

- Intel® I210 PCI Express Gigabit Ethernet controller
- Intel® I217 Gigabit Ethernet Phy
- Integrated 10/100/1000 transceiver
- Fully compliant with IEEE 802.3, IEEE 802.3u, IEEE 802.3ab

EXPANSION

- 1 Mini PCIe slot
 - Supports USB and PCIe signals
 - Supports mSATA, Wi-Fi or 3G*
 - Supports half size or full size Mini PCIe card

I/O PORTS

- Front Panel
 - 1 power button with LED
 - 1 reset button
 - 1 status LED
 - 1 HDD LED
 - 2 Type A USB 2.0 ports
 - 4 DB-9 RS232 serial ports
- Rear Panel
 - 2 RJ45 LAN ports
 - 1 VGA port
 - 2 Type A USB 3.0 ports
 - 2 Type A USB 2.0 ports
 - 2 DB-9 RS232/422/485 serial ports (with power)
 - 1 9~36V DC-in 3-pole terminal block

POWER

- Power input voltage: 9~36V DC-in

ENVIRONMENT

- Temperature
 - Operating: 0°C ~ 45°C
 - Storage: -20°C ~ 85°C
- Operating Vibration
 - IEC68-2-64
- Operating Shock
 - Half sine wave 3G, 11ms, 3 shock per axis

CONSTRUCTION

- Aluminum + SGCC

MOUNTING

- Wall mount
 - Mounting brackets and screws*

DIMENSIONS

- 235mm x 63.2mm x 222mm (W x H x D)

WEIGHT

- TBD

OS SUPPORT

- Windows XP (32-bit) (limited function)
- Windows 7, WES 7, Windows 8, WE8S
- Linux (Distribution available upon request)

OTHER FEATURES

- Watchdog timeout programmable via software from 1 to 255 seconds

CERTIFICATION

- CE
- FCC Class A
- RoHS



EC500-HD

Wall Mounting

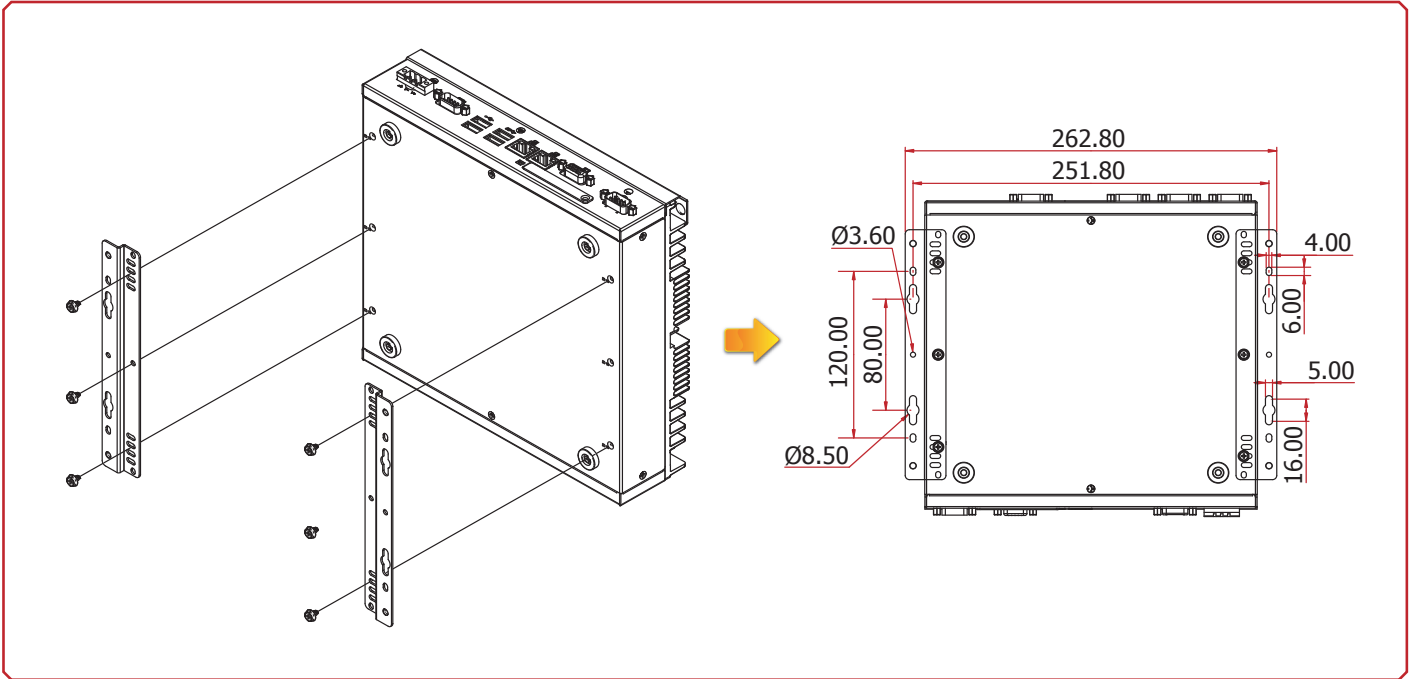

EC500-HD

► Ordering Information

Model Name	Part Number	Description
EC500-HD6060	750-EC5000-000G	Fanless, i7/i5/i3, H81, 6 COM, 6 USB, RoHS

► Optional Items

Optional Items	Part Number	Description
CPU	785-1150DL	CPU, LGA1150, Long-Term Support, RoHS
Memory	785-RSOD38G-L	SODIMM, DDR3L Module (supports dual voltage 1.5V DDR3/1.35V DDR3L), 8GB, RoHS
	785-RSOD34G-L	SODIMM, DDR3L Module (supports dual voltage 1.5V DDR3/1.35V DDR3L), 4GB, RoHS
	785-RSOD32G-L	SODIMM, DDR3L Module (supports dual voltage 1.5V DDR3/1.35V DDR3L), 2GB, RoHS
HDD	785-H25500G	2.5" SATA HDD, 500GB, RoHS
	785-H25320G	2.5" SATA HDD, 320GB, RoHS
	785-S251TBG	2.5" SATA SSD, 1TB MLC, RoHS
	785-S25512G	2.5" SATA SSD, 512GB MLC, RoHS
	785-S25256G	2.5" SATA SSD, 256GB MLC, RoHS
	785-S25128G	2.5" SATA SSD, 128GB MLC, RoHS
	785-S25064G	2.5" SATA SSD, 64GB MLC, RoHS
mSATA	785-MS128GMF	mSATA Card, 128GB MLC, RoHS
	785-MS64GMF	mSATA Card, 64GB MLC, RoHS
	785-MS32GMF	mSATA Card, 32GB MLC, RoHS
	785-MS16GMF	mSATA Card, 16GB MLC, RoHS
	785-MS08GMF	mSATA Card, 8GB MLC, RoHS
	785-MS04GMF	mSATA Card, 4GB MLC, RoHS
Wi-Fi	761-110091-000G	Wi-Fi Kit, RoHS
Power Cord	785-PWRD	Power Cord, Standards (USA/EUR/CH), 1.8m, RoHS
Power Adapter	671-110003-100G	120W, 19V/6.31A, Level 6, RoHS
Wall Mount	761-EC5410-000G	Wall Mount Kit, RoHS

► Packing List

• 1 EC500 system unit
• 1 CD disk includes:
- Drivers / Manual